



STRUCTURAL SHOWER SYSTEMS

PRODUCTS, FEATURES, BENEFITS & APPLICATIONS

PRODUCT CATALOG 2023

The most innovative
curbless shower system
on the market.



**CURBLESS &
CURBED
SYSTEMS**

TABLE OF CONTENTS

KurbX[®] Product Catalog 2023

CURBLESS AND CURBED SHOWER SYSTEMS

Benefits and Details

PAGE 2

STEP-BY-STEP CUSTOM ORDER

Curbless and Curbed shower installation kit from start to finish

PAGE 3

SHOWER PANS

KurbX[®] Customizable Structural Shower Pans

PAGE 4, 5, & 6

SHOWER PAN FILLER

ExtendIT - 3" x 4' long Mini Pitch Fillers

PAGE 7

SHOWER CURBS

KurbIT[®] Shower Curbs

PAGES 8, 9 & 10

INSTALLATION PACKAGES

KurbX[®] Installation Packages

PAGES 11, 12 13 & 14

SHOWER DRAINS

KurbX[®] 4" Square Drain Assemblies

PAGES 15 & 16

WATERPROOFING KITS

KurbX[®] Waterproofing Solutions

PAGES 17 & 18

WATERPROOFING PRODUCTS

SEELIT[®] Waterproofing A La Carte Items

PAGES 19 & 20

INSTALLATION RESOURCES

Access video tutorials and CAD drawings

PAGE 21

WARRANTIES AND CONDITIONS

Legal Agreement

PAGE 22

BENEFITS AND DETAILS

KurbX[®] Curbless and Curbed Shower Systems



QUICK & EASY ASSEMBLY

Simple, 3 part screwless drain assembly is self contained.



LIMITED LIFETIME WARRANTY



NO MORTAR REQUIRED

No mortar required for most pan installations.



LUXURY MEETS FUNCTIONALITY

Clean curbless look with precision engineered slopes.



IDEAL FOR MULTIPLE INSTALLATION TYPES

Direct to joists, solid wood substrates, concrete slab and 2nd floor & higher concrete.



CURBLESS OR CURBED

Add a proprietary low profile curb to any curbless KurbX system to create a curbed shower.

- All pan sizes can be cut to any shape or size on site or place them side by side for large showers. Structural pans can span 16" OC joists making curbless installs easy and cost effective.
- No thinset required for pan installation on wood substrates.
- No special thin-set or grout required for small mosaic tile installations.
- Ideal installation can be ready for tile the same day.
- Can be installed during rough framing phase of construction.
- Unique, textured pan surface provides superior waterproofing adhesion.
- Centered drains for optimal design orientation making large format installations flawless.
- Self contained drain connection eliminates the need for additional waterproofing or gaskets.
- KurbX is compatible with all in-floor heating systems.
- Highly competitive pricing in both curbed and curbless shower markets.

STEP-BY-STEP ORDERING GUIDE

Curbless and Curbed shower installation kit from start to finish

Kurbx offers all products and installation packages needed for a complete shower system. Follow the steps below to pick the right products for your project.

STEP ①

Choose a shower pan

PAGES 5 & 6

Need an Extend-IT Mini Pitch Filler?

GO TO PAGE 7

Need a curb?

GO TO PAGES 9 & 10

STEP ②

Choose an installation package

PAGES 11, 12 13 & 14

STEP ③

Choose a drain assembly

PAGES 15 & 16

STEP ④

Choose a Waterproofing Kit

PAGES 17 & 18

Need additional a la carte waterproofing items?

GO TO PAGES 19 & 20



Stay ahead of the curb with KurbX.

CURBLESS

Install the easiest tile-over curbless shower system on the market!



**BEGIN
STEP-BY-STEP
PRODUCT
SELECTION**

SHOWER PANS

KurbX[®] Customizable Structural Shower Pans

KurbX structural shower pans combine the strength & durability of a traditional mud-set with the versatility of foam

APPLICATION



CURBLESS



CURBED

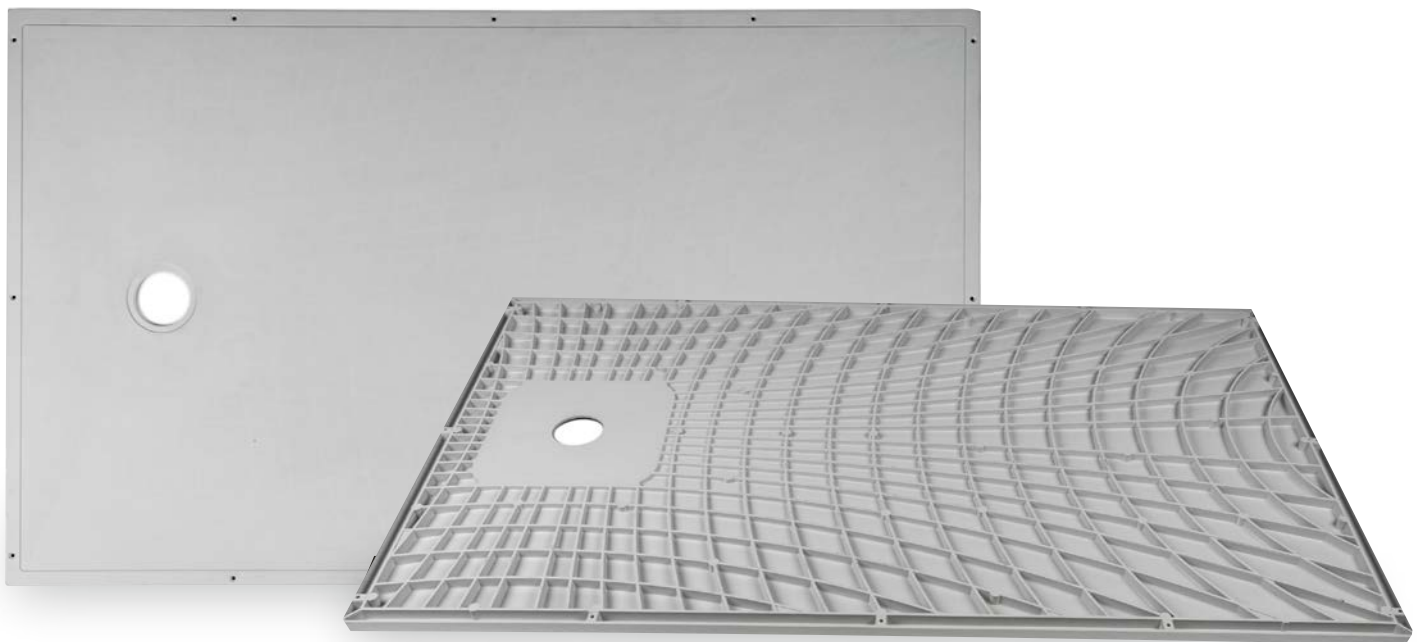

- Perfect for curbed or curbless installations.
Install directly to joists, solid wood substrates and concrete.
Pans can be cut to any size on-site.
Thin profile - only 15/16" thick at perimeter.
Centered drain for aesthetically pleasing finish.
100% recyclable.

SIZE OPTIONS | ITEM CODES

60" X 36" KurbX®
Center Drain Shower Pan

SB6036-CD

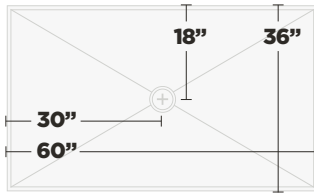

60" X 36" KurbX®
Off Set Drain Tub Replacement

SB6036-OD-TR

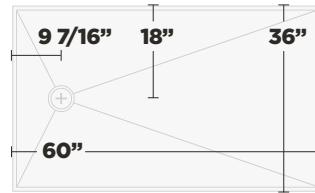

48" X 48" KurbX®
Center Drain Shower Pan

SB4848-CD

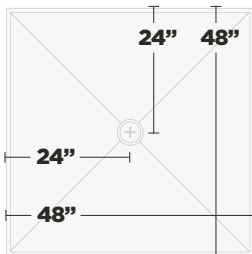

60" X 48" KurbX®
Center Drain Shower Pan

SB6048-CD

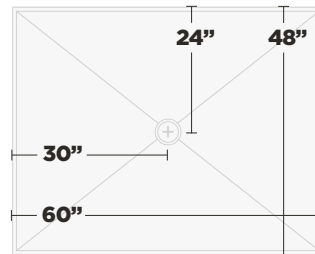

59" X 59" KurbX®
Center Drain Shower Pan

SB6060-CD

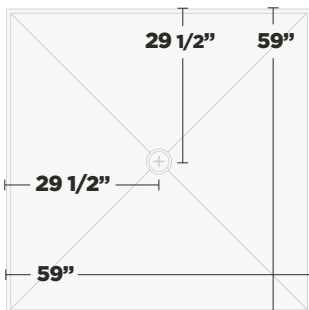

71" X 47 1/4" KurbX®
Center Drain Shower Pan

SB7248-CD

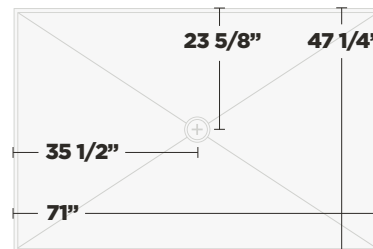

SHOWER PAN FILLER

ExtendIT - 3" x 4' long Mini Pitch Fillers

Drain position adjuster

ITEM CODE

3-EXTENDIT-48

Two Pack

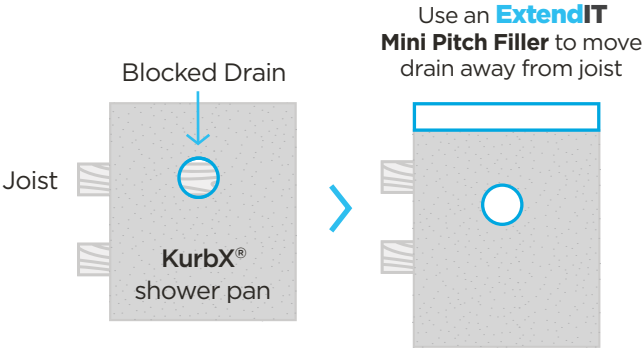

- > Pre-pitched to match pan surface and support pan water drainage.
Can use to extend pitch up to 3" per side.
Adjust position of the drain to avoid alignment directly over floor joist.
Cut to any length on-site.

CURBED

KurbIT[®]

Add our proprietary low profile curb to any KurbX system to create a curbed shower.



**ADD A CURB
TO YOUR
SHOWER
SYSTEM**

SHOWER CURBS

KurbIT[®] - Low Profile Shower curbs

APPLICATION



CURBED

Simply add a **KurbIT[®] shower curb** to any pan to create a beautiful curbed shower

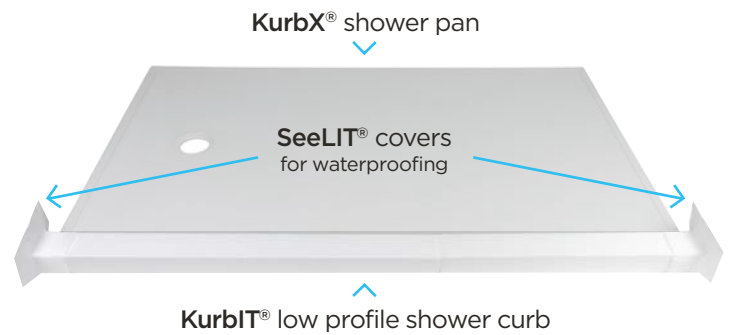

- > KurbIT shower curbs are made of strong, high density EPS foam (3.25 psi)
Specifically engineered to fit the pan at the floor creating a straight, low profile curb that is easy to install, waterproof and tile.

LENGTHS | ITEM CODES

We've combined our 24" & 36" curbs to create 48", 60" and 72" curbs.

36" Shower KurbIT® Curb & Covers

36" Curb, 2 tile spacers & 2 SeeLIT covers

KurbIT-36-COV



48" KurbIT® Shower Curb & Covers

Two 24" curbs, 4 tile spacers & 2 SeeLIT covers

KurbIT-48-COV

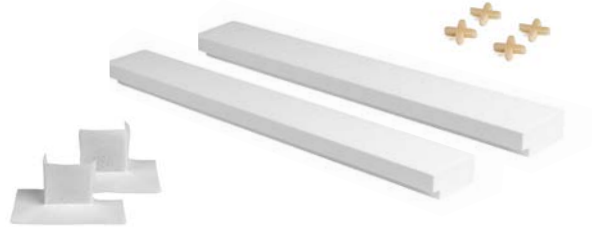

60" KurbIT® Shower Curb & Covers

24" curb & 36" curb, 4 tile spacers & 2 SeeLIT covers

KurbIT-60-COV



72" KurbIT® Shower Curb & Covers

Two 36" curb, 4 tile spacers & 2 SeeLIT covers

KurbIT-72-COV



LENGTHS OVER 72":

For larger showers, simply add the necessary individual curb sizes to achieve your desired curb length.

24" KurbIT® Shower Curb

24" Curb & 2 tile spacers

KurbIT-24



36" KurbIT® Shower Curb

36" Curb & 2 tile spacers

KurbIT-36



INSTALLATION PACKAGES

KurbX[®] Installation Packages

Our extensive on-site experience has allowed us to develop a variety of installation packages that will assist the installer with any type of installation.



➤ **KurbX Installation Packages provide:**

- Increased installation efficiency for every trade.
- All necessary parts needed per installation type.
- A package for every substrate.
- Custom installation packages for bulk orders upon request.

INSTALLATION PACKAGE 1

Wood Substrate Installation Package With Drain Support Block

APPLICATION



CURBLESS

Installations on **ALL wood substrates**.



CURBED

Installations on **ALL wood substrates** when there is **NO plumbing access from underneath**.



ITEMS INCLUDED

- 1 Proprietary drain support block
- 2 Drain support block cleats
- 1 Drain Waste Connector **Choose from PVC (white) or ABS (black)**
- 1 Mini tube of pure silicone
- 6 10oz tubes of approved construction adhesive
- 20 Coated deck screws for fastening the pan to the substrate
- 1 2" driver bit

2" DRAIN OPTIONS | ITEM CODES

IP-1-PVC



Package 1 - PVC

Package items include one **WHITE PVC** Drain Waste Connector

IP-1-ABS



Package 1 - ABS

Package items include one **BLACK ABS** Drain Waste Connector

INSTALLATION PACKAGE 2

Wood Substrate Installation Package

APPLICATION



CURBED

Installations on **ALL wood substrates** when there **IS plumbing access from underneath.**



ITEMS INCLUDED

- 1 Drain Waste Connector **Choose from PVC (white) or ABS (black)**
- 1 Mini tube of pure silicone
- 4 10oz tubes of approved construction adhesive
- 20 Coated deck screws for fastening the pan to the substrate
- 1 2" driver bit

2" DRAIN OPTIONS | ITEM CODES

IP-2-PVC



Package 2 - PVC

Package items include one **WHITE PVC** Drain Waste Connector

IP-2-ABS



Package 2 - ABS

Package items include one **BLACK ABS** Drain Waste Connector

INSTALLATION PACKAGE 3

Wood or Concrete Substrate Package for New Construction

APPLICATION

✓ **CURBLESS**

✓ **CURBED**



ITEMS INCLUDED

- 1 PVC Drain Waste Connector **Choose from PVC (white) or ABS (black)**
- 1 Mini tube of pure silicone
- 20 Coated deck screws for fastening the pan to the substrate **(Note: Use tap cons for concrete installations) - Not provided**
- 1 2" driver bit

2" DRAIN OPTIONS | ITEM CODES

IP-3-PVC



Package 3 - PVC

Package items include one **WHITE PVC** Drain Waste Connector

IP-3-ABS



Package 3 - ABS

Package items include one **BLACK ABS** Drain Waste Connector

SHOWER DRAINS

KurbX[®] 4" Square Drain Assemblies

Our solid Stainless Steel grate and frame provides strength and durability without compromising design.

✓ **LIMITED LIFETIME WARRANTY**

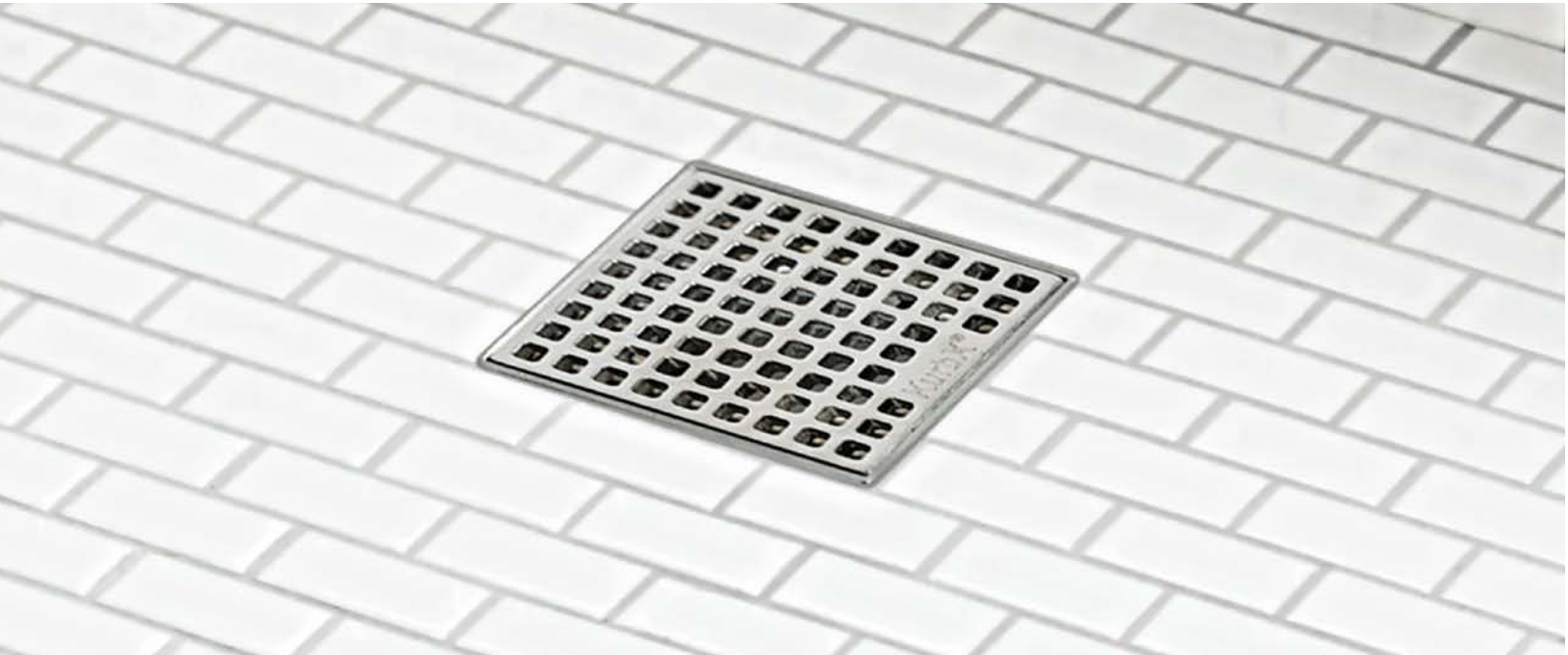

- Our snap in grates set firm but remain easy to remove for cleaning using the provided grate key.

Quick and easy shower drain assembly.

Made of durable, corrosion-resistant solid stainless steel.

FINISHES | **ITEM CODES**

Grid Pattern Drain



GP-100-BS

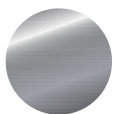

Brushed Stainless
Grid Pattern

GP-200-CH



Chrome
Grid Pattern

GP-300-ORB



Oil rubbed bronze
Grid Pattern

GP-400-MB



Matte Black
Grid Pattern

WATERPROOFING KITS

SEELIT[®] - KurbX[®]

Waterproofing Solutions

Whether you're looking to waterproof your shower only or the entire bathroom, KurbX has the solution to a seamless, watertight bathroom.

✓ **EASY APPLICATION**

✓ **TILE CRACK PREVENTION**



STEP FOUR

- Approved for steam showers.
- Do not apply to concrete where hydrostatic pressure is present.
- Membrane must be covered by finish flooring.
- Do not use to bridge existing expansion joints.
- Follow TCNA guidelines for deflection criteria on wood substrate.

WATERPROOFING KITS | ITEM CODES

SEELIT® – liquid waterproof Membrane MAX

Approximately 120 sq. ft. Coverage

| SEELIT-MAX-1000



ITEMS INCLUDED

- 1 **2 gallons** of waterproofing
- 1 **82'** of Joint tape
- 4 Internal corners
- 2 External corners
- 1 Tube of acrylic caulk
- 1 4" disposable brush
- 1 Pair of gloves
- 1 Paint roller cover
- 1 Paint roller handle

SEELIT® – liquid waterproof Membrane MIN

Approximately 30 sq. ft. Coverage

| SEELIT-MIN-500



ITEMS INCLUDED

- 1 **1/2 gallon** of waterproofing
- 1 **27'** of Joint tape
- 4 Internal corners
- 2 External corners
- 1 Tube of acrylic caulk
- 1 4" disposable brush
- 1 Pair of gloves
- 1 Paint roller cover
- 1 Paint roller handle

WATERPROOFING PRODUCTS

SEELIT® - A La Carte Items

Choose any additional waterproofing items for your curbless or curbed shower project.

SEELIT® - Liquid Waterproofing



- Ready to use liquid latex waterproofing and crack prevention membrane specifically formulated for use beneath commercial and residential tile and stone interior and exterior applications. SEELIT Liquid Waterproofing elastomeric properties reduce the risk of substrate cracks transferring to finished tile and stone flooring while providing a continuous moisture barrier for wet areas.

Dry time is typically 1 hr depending on room conditions.

PAIL SIZES | ITEM CODES

2 Gal - SEELIT® Liquid Waterproofing Pail

Approximately 120 sq. ft. Coverage

SEELIT-SOLO-2GAL

1/2 Gallon - SEELIT® Liquid Waterproofing Pail

Approximately 30 sq. ft. Coverage

SEELIT-SOLO-1/2GAL

LIMITATIONS: Do not apply to concrete where hydrostatic pressure is present. Do not use as adhesive. Membrane must be covered by finish flooring. Do not use to bridge existing expansion joints. Follow TCNA guidelines for deflection criteria on wood substrate.

USE ON: Use SEELIT® - Liquid Waterproofing on concrete (porous, non porous or light weight), gypcrete, OSB, existing vinyl, epoxy coatings, glazed or unglazed existing tile, natural stone, terrazzo, PVC, steel, aluminum, stainless steel, adhesive residue, cement backer boards and polystyrene foam.

A-LA-CARTE | ITEM CODES

SEELIT® Joint Tape 82' roll

| SEELIT-JT-82



SEELIT® Joint Tape 27' roll

| SEELIT-JT-27



SEELIT® Internal Corners

| SEELIT-INT-2



SEELIT® External Corners

| SEELIT-EXT-2



SEELIT® Covers

| SEELIT-COVERS



INSTALLATION RESOURCES

Access video tutorials and cad drawings

View detailed installation video tutorials
and architect drawings at kurbx.com.



CONTACT US

Interested in becoming a distributor of KurbX® products?

For inquiries contact us at:

815 747-6700 | INFO@KURBX.COM

WARRANTIES AND CONDITIONS

Legal Agreement

WARRANTIES AND OBLIGATIONS

KurbX warrants to Buyer that it holds and will pass marketable title to the goods sold hereunder. Certain of KurbX products come with a Limited Warranty. IF Buyer is not the end user of the of the goods sold hereunder, Buyer agrees to provide to any immediate buyer (Remote Purchaser) the Limited Warranty and Disclaimer to End-Use (Remote) Purchasers issued by KurbX for the Limited Warranty applicable to KurbX's products. Please refer to KurbX's published literature that accompanies or relates to those products. Any remedies stated in such warranties are the exclusive and only remedies provided by KurbX for the breach of Warranty. Certain of KurbX's Limited Warranties exclusive coverage for any product that is moved to a new location. KurbX's products should never be reused without prior written consent by KurbX.

EXCLUSIONS AND CONDITIONS

KurbX's obligations with respect to the express warranties and remedies contained herein are conditioned on the following: (i) Buyer's return of nonconforming goods, if authorized by KurbX (excluding freight and labor) and (ii) be installed by individuals trained and certified as a professional with respect to such installations and be installed, used, repaired and maintained by Buyer and Remote Purchaser in accordance with KurbX's warnings and instructions, National, State and Local codes or regulations.

DISCLAIMER OF IMPLIED WARRANTIES

KurbX gives no warranties to Buyer except those expressly contained herein. KurbX disclaims all other warranties implied by law, usage of the trade, course of dealing or course of performance including, but not limited to, the implied warranties of merchantability and fitness for a particular purpose.

INDEMNIFICATION

Buyer agrees to indemnify, hold harmless and defend KurbX from and against all claims and lawsuits, including attorney's fees, to the extent of the Buyer's negligent acts or omissions to act cause injury, damage or loss to customers of KurbX's products.

LIMITATIONS OF LIABILITY

The following limitations of KurbX's liability are acknowledged by the parties to be fair and reasonable and shall apply to any act or omission hereunder, and to any breach of this contract of which these terms and conditions form a part.

DISCLAIMER OF DAMAGES

In no event shall KurbX be liable for special, indirect, consequential or incidental damages whether arising under contract, warranty, tort, negligence, strict liability or any other theory of liability. Such damages include, but are not limited to, loss of profits, loss of use of the goods, damage to property and claims of third parties.

REPLACEMENT OF PARTS/ADAPTORS

Buyer acknowledges that if KurbX supplies parts and/or adaptors, and Buyer replaces a part or adaptor produced by another manufacturer, then all of KurbX's warranties to Buyer and to Remote Purchaser will be voided and Buyer will assume all liability for any damage, injury or loss suffered by Remote Purchaser arising out of this unauthorized modification.

NOTICE OF TIME OF CLAIMS

Buyer agrees to inspect all products against shipping papers and for damage or shortage upon receipt of goods at destination and every claim for loss, damage in transit, or other cause visible upon inspection shall be made with carrier. Claims of shortage must be made within 5 days of receipt.



SEELIT[®]

KurbIT[®]

**The most innovative curbless
shower system on the market.**

Adam Droessler
PARTNER/DIRECTOR OF SALES

adam@kurbx.com
224 301-0987

Bill Buettner
NATIONAL SALES/TRAINER

bill@kurbx.com
715 937-1790

Jessica Kaufman
MARKETING/INSIDE SALES

jessica@kurbx.com
715 803-8737



KurbX.com

815 747-6700 | INFO@KURBX.COM

