

36



THE SMART ENTRY TO YOUR HOME

WITH DOORBIRD YOU WILL
NEVER MISS A VISITOR.

Designed,
developed and
made in Germany

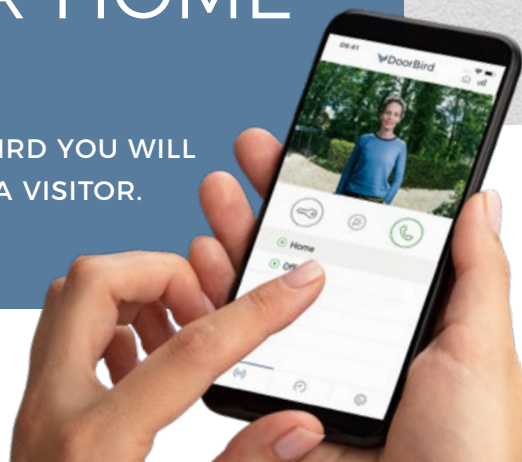

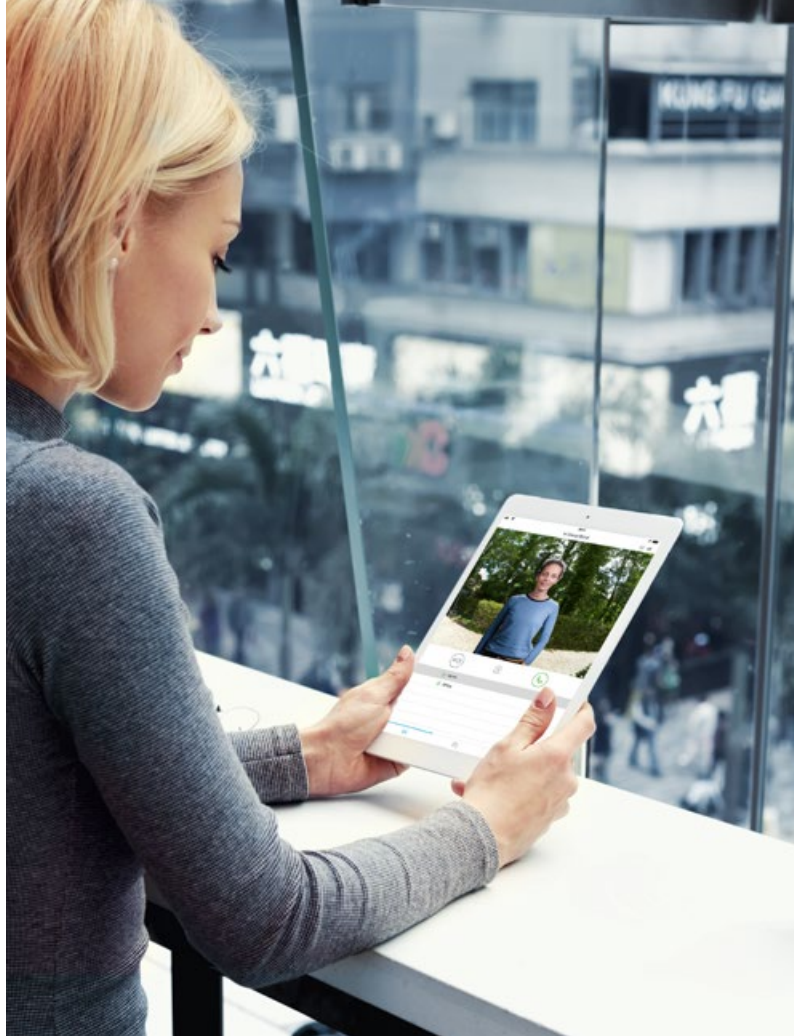



SMART HOME STARTS AT THE FRONT DOOR

DoorBird is the smart solution for your house entrance. Simply connect your DoorBird IP Video Door Station to your smartphone and talk to your visitor – anywhere you are. The IP Video Door Station can be used as a stand-alone unit or can be integrated into an existing Smart Home platform. Even existing classic installations such as an electric door opener can still be used and controlled via the DoorBird App.

CONTENT

HOW DOES IT WORK?	4
IP VIDEO DOOR STATIONS	6
CONFIGURATOR	18
SURFACES AND COLORS	20
CUSTOM SOLUTIONS	22
IP ACCESS CONTROL DEVICE A1121	23
IP VIDEO INDOOR STATION A1101	24
OPTIONAL ACCESSORIES	26
IP DOOR CHIME A1061W	26
2-WIRE ETHERNET POE CONVERTER A1071	26
IP VIDEO DOOR STATION D1101UV UPGRADE	26
INTERNET FIREWALL A1051	26
IP I/O DOOR CONTROLLER A1081	27
TABLE STAND A8003	27
WEDGE CORNER WALL-MOUNT ADAPTER A8001	27
ANGLE CORNER WALL-MOUNT ADAPTER A8002	27
BLUETOOTH KEYFOB REMOTE A8007	27
TRANSPONDER KEY FOB A8005	27
REFERENCES	28
SUSTAINABILITY	30

QUALITY MADE IN GERMANY

All DoorBird products are designed, developed and produced by Bird Home Automation GmbH in Berlin, Germany. We manufacture all products with the greatest care and precision, and deliver them to our customers all over the world.

More than 120 employees are committed to continuously developing DoorBird in order to guarantee the highest quality, longevity and customer satisfaction. For us "Made in Germany" is not only a seal of quality, but a philosophy.



HOW DOES IT WORK?

Imagine, you are not at home and your children have locked themselves out or the courier wants to deliver a parcel. With DoorBird this is no longer a problem. Every time someone rings the doorbell you will get a push notification on your smartphone or tablet. Via the DoorBird App you are not only able to talk to the visitor but also see them live in HD quality. You will never miss a visitor again. With DoorBird you are on the move and yet at home, even if a burglar rings at the door to check if someone is at home.

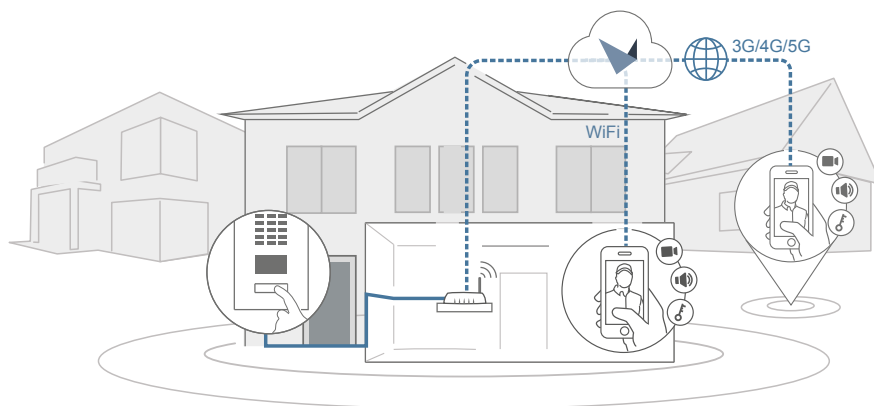

FEATURES

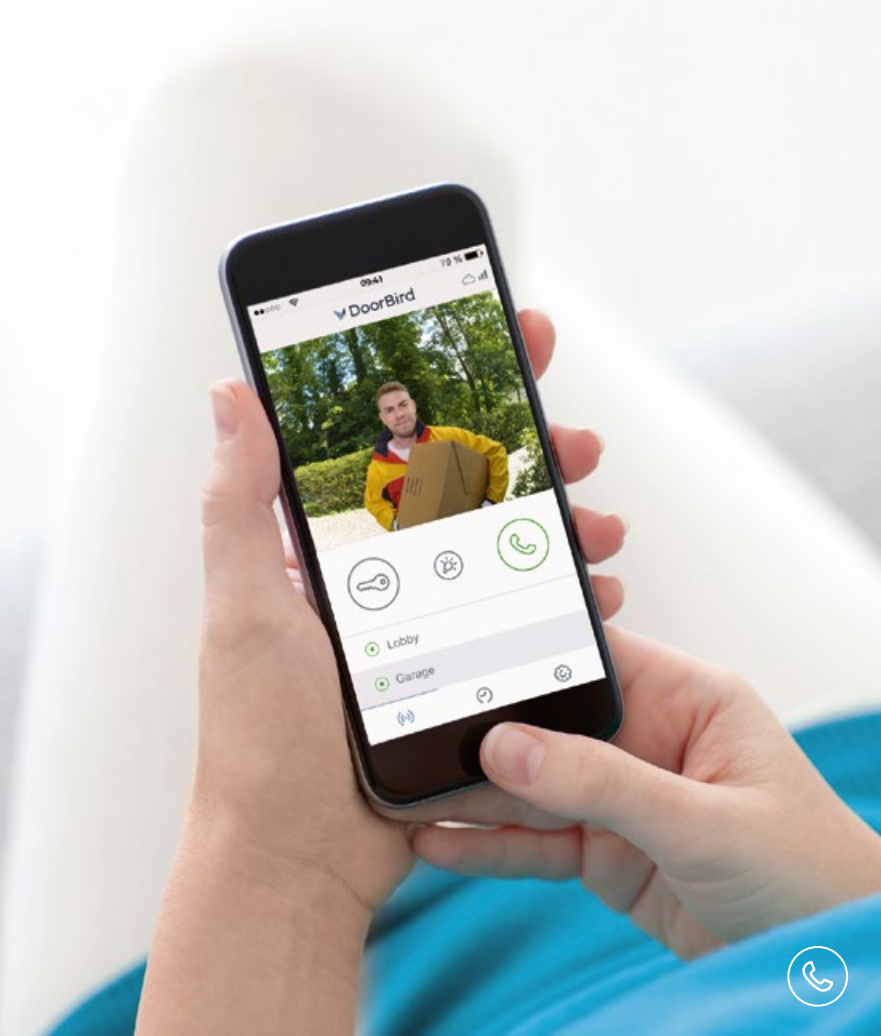

Video and audio call

- On smartphones, tablets (iOS, Android), IP and landline phones (SIP)



Smart Transmission Mode (STM)

- Real-time audio / video communication, optimized for mobile devices via WiFi, 3G, 4G, 5G



Open API

- Local interface for integration with third-party systems and SIP



Automatic door buzzer

- For use in medical offices and office environments



Smart Home & NVR compatible

- Control4, Loxone, Crestron, Synology, AVM FRITZ!Fon, URC, QNAP, RTI, ELAN, Fibaro, Bang & Olufsen and others



Free visitor history

- Store still images for free, optional video recording available



Geofencing

- Automatic door and gate opening when returning home



A SOLUTION FOR EVERY NEED





From compact entry-level models through classic call button door stations to universal keypad models, our product variety leaves nothing to be desired. With DoorBird you get the perfect solution for single-family homes as well as for large residential buildings, apartment complexes and commercial spaces.



D1101V
Surface-mount

D1102V
Surface-mount

D1101V & D1102V FEATURES

-  WiFi enabled
 - Works within a WiFi network, no LAN cable needed
-  Small and compact
 - For example, for mounting on door frame
-  Adjustable view angle
 - Wall adapter enables exact view direction (separately available for D1101V and D1102V Surface-mount)
-  Bluetooth Low Energy (BLE)
 - For access control, compatible external sensors and smart locks

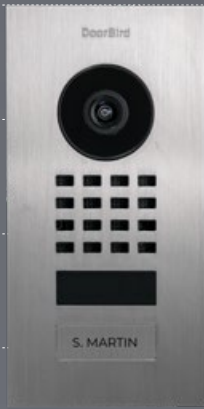

D1101V
Flush-mount



D1102V
Flush-mount



D2101V

- 0 mm
- 50 mm (1.96 in)
- 100 mm (3.93 in)
- 150 mm (5.90 in)
- 200 mm (7.87 in)
- 250 mm (9.84 in)

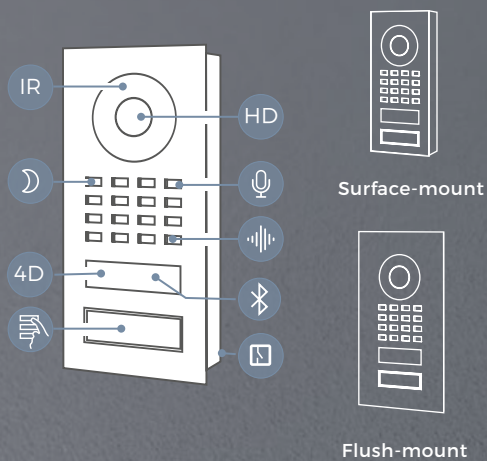

D21X FEATURES

- RFID reader**
 - Configurable remotely via App (e.g. time frame)

- Light sensor**
 - For night vision mode

- Two freely configurable bi-stable switching relays**
 - Two doors or gates can be controlled via App
 - Status configurable via App: temporary or permanent circuit

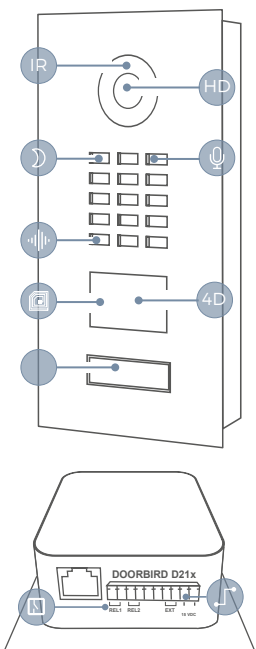



D21X FEATURES

HD HDTV Video

- Ultra wide-angle, hemispheric lens, 180°

IR Night vision

- With 12 Infrared LEDs



Noise reduction and echo cancellation (AEC, ANR)

4D Motion sensor with 4D technology

- Distance up to 10 m adjustable via App (interval: 1 m)



Easy connection to the network

- Connection via a network cable or bell wire via 2-Wire Ethernet PoE Converter "DooBird A1071" (PoE, network data)



Individual action schedules, e.g.:

- RFID card "abc" has only access on Wednesday from 9 am until 11 am
- 4D motion sensor switches on external lamp between 9 pm and 6 am

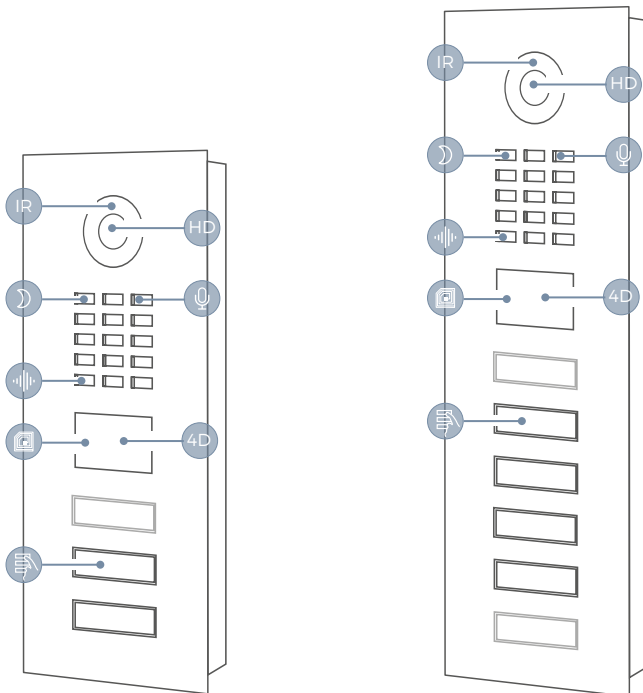



DoorBird

C. Berger

S. Martin

Martin

DoorBird

DoorBird

DoorBird

C. Berger



SINGLE-FAMILY RESIDENCE / SMALL BUSINESS
Access control also via PIN code • 1 - 2 call buttons

D1101KV AND D1102KV FEATURES



Keypad Module

- Configurable via App
- More than 500 individual PIN codes
- Individual events (e.g. switch a relay, HTTP(s) requests)



WiFi enabled

- Works within a WiFi network, no LAN cable needed

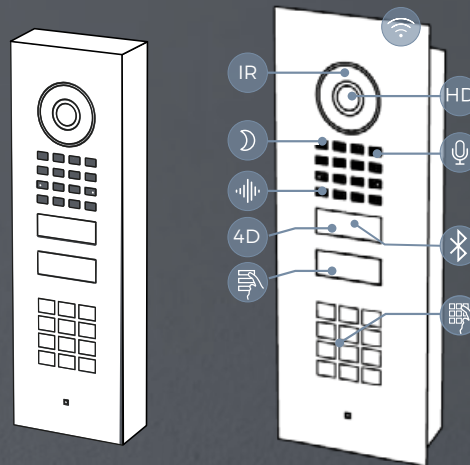

0 mm

50 mm
(1.96 in)

100 mm
(3.93 in)

150 mm
(5.90 in)

200 mm
(7.87 in)

250 mm
(9.84 in)

300 mm
(11.81 in)

350 mm
(13.77 in)

400 mm
(15.74 in)



D1101KH Modern



also available with
 round call button
 (D1101KH Classic)



D2101KV

D1101KH FEATURES

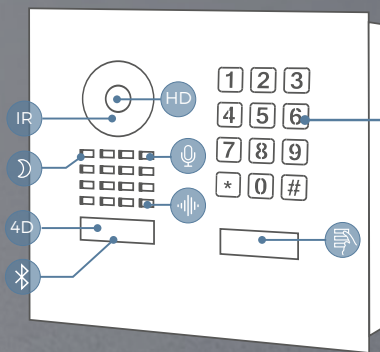

Keypad Module

- Configurable via App
- More than 500 individual PIN codes
- Individual events (e.g. switch a relay, HTTP(s) requests)

also available with
 surface-mounting
 housing



D1101KH Modern
 Surface-mount



D1101KH Classic
 Surface-mount

D21X FEATURES

Info Module

- 3.5", illuminated
- Optionally with stainless steel cover

Keypad Module

- Configurable via App
- Up to 500 individual PIN codes
- Individual events (e.g. trigger a relay, HTTP(s) request)

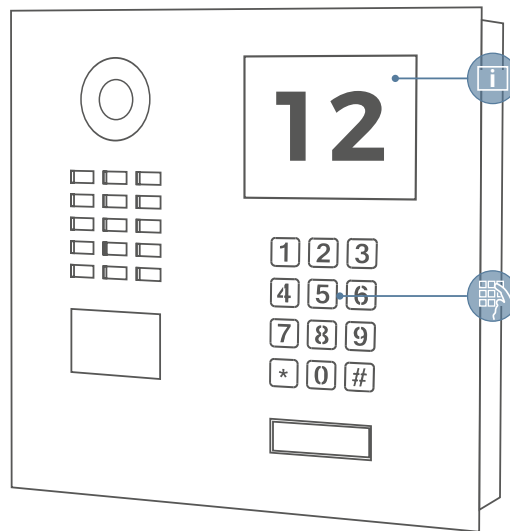
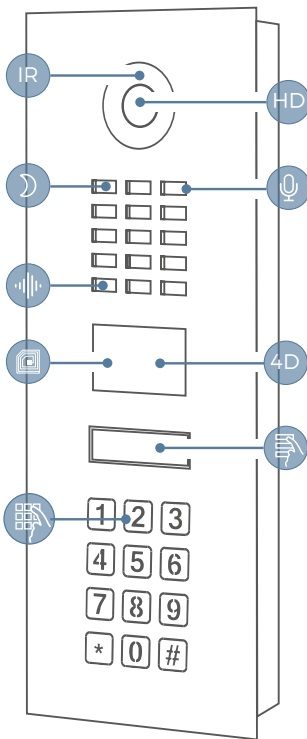
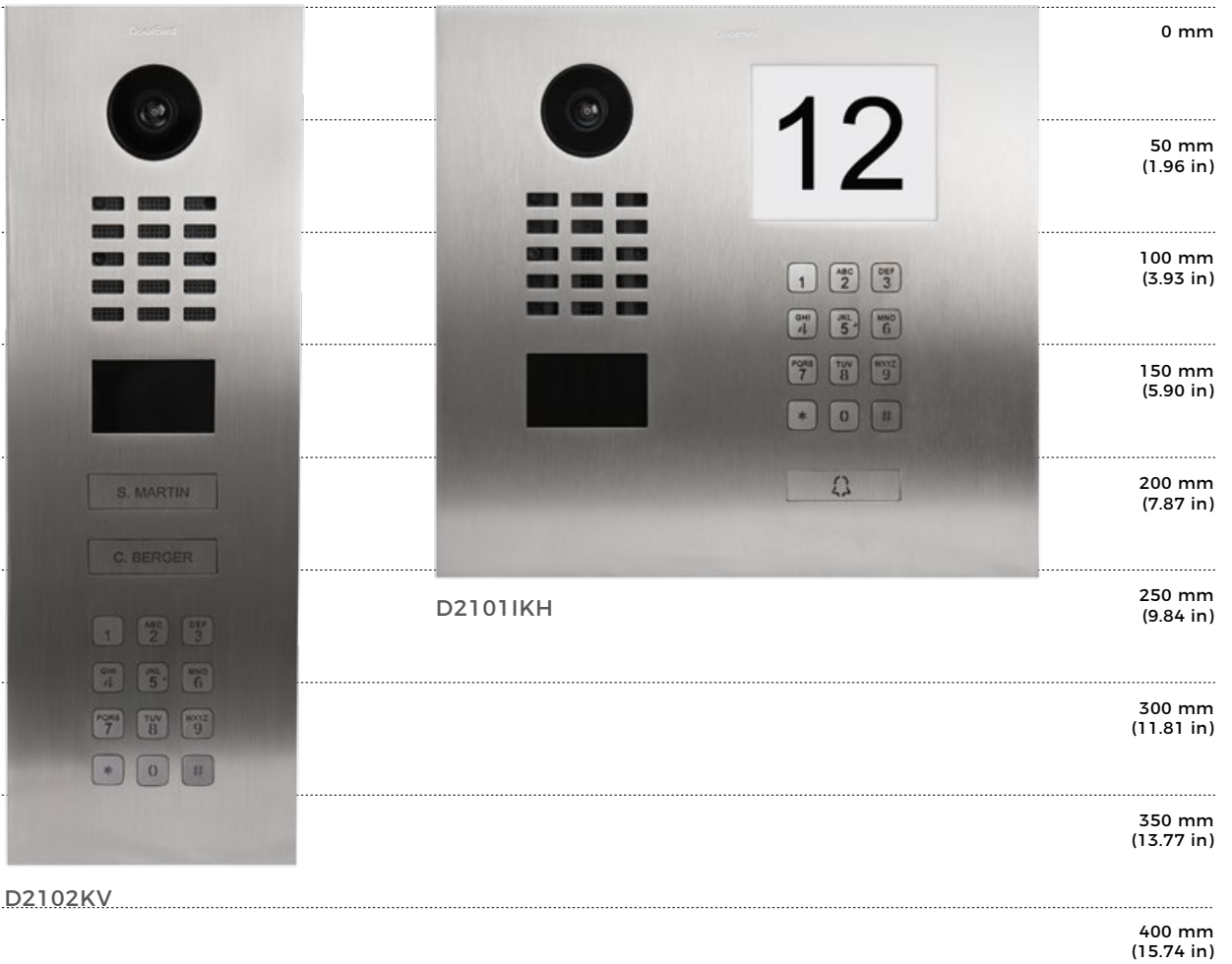

BIOMETRIC IDENTIFICATION WITH A HUMAN TOUCH

DoorBird cooperates only with the best of its class: Our fingerprint reader is equipped with the technology of Fingerprint Cards AB (Fingerprints™) – the world's leading biometrics company, with its roots in Sweden. Fingerprints™ technology is found in hundreds of millions of devices and applications, and is used billions of times every day, providing safe and convenient identification and authentication with a human touch.

The solution by DoorBird brings together superior biometric performance and security, high standard of quality components and a capacitive touch sensor for our IP door stations and IP access control units.



D1101FV
Fingerprint 50
Surface-mount

D1102FV
Fingerprint 50
Surface-mount

D1101FV
Fingerprint 50
Flush-mount



- Fingerprint reader
- Supported number of fingerprints: 50
 - Status LED (RGB)
 - Touch sensor



D1102FV
Fingerprint 50
Flush-mount



D2101FV Fingerprint 50



D2102FV Fingerprint 50

- 0 mm
- 50 mm (1.96 in)
- 100 mm (3.93 in)
- 150 mm (5.90 in)
- 200 mm (7.87 in)
- 250 mm (9.84 in)
- 300 mm (11.81 in)
- 350 mm (13.77 in)

SINGLE-FAMILY RESIDENCE / SMALL BUSINESS
Access control also via Fingerprint • 1 - 2 call buttons

Surface-mount

Flush-mount

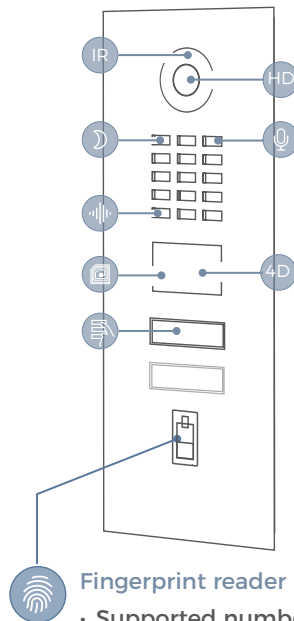

- Fingerprint reader**
- Supported number of fingerprints: 50
 - Status LED (RGB)
 - Touch sensor

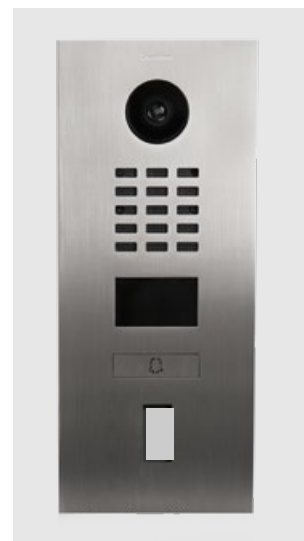

Also available with integration option for ekey Home FS OM I "Black Edition", not included in delivery (D2101FV EKEY or D2102FV EKEY)



D1812 HYBRID UPGRADE

Upgrade the DoorKing® 1812 series (Classic or Plus, Surface or Flush Mount) with DoorBird IP Technology by replacing the front panel. The existing DoorKing® 1812 analog telephone system stays online – and now the user has full IP control of their driveway with the DoorBird App for iOS/Android – allowing for 2-way audio, 1-way video, visitor management, and access control onsite or remotely from anywhere in the world.

- ✓ DoorBird IP video technology
- ✓ Easy installation via PoE
- ✓ Keyless access from App, Keypad, RFID (13.56 KHz) and Wiegand
- ✓ Remotely configurable
- ✓ Smart Home & NVR compatible, e.g. Control4, URC, RTI, Elan



D21DKH



D21DKV

0 mm

50 mm
(1.96 in)

100 mm
(3.93 in)

150 mm
(5.90 in)

200 mm
(7.87 in)

250 mm
(9.84 in)

300 mm
(11.81 in)

350 mm
(13.77 in)

400 mm
(15.74 in)

BUILDINGS WITH 1-200 UNITS
Access control also via PIN code

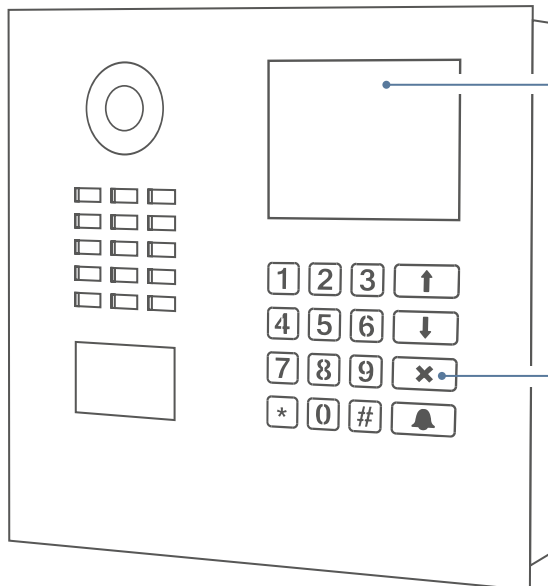

Display Module

- Distance sensitivity on/off
- Individually configurable, e.g.: display of the resident directory, welcome message



Keypad Module

- Configurable via App
- Individual PIN codes
- Individual events (e.g.: trigger a relay, push notification, ...)

SMART VARIETY

Are you looking for a personalized and custom-made solution that goes beyond what we offer in our shop? Then use our Online Configurator and design your own customized DoorBird in just a few steps! Choose the size, finish, color and additional features according to your wishes.

More Informations:
www.doorbird.com/configurator



ACCESSIBILITY MODULE

Our IP video door station can be expanded using our 3D Configurator to include the “Accessibility Module” for people with impaired hearing. The module was developed for use in public buildings, kindergartens, educational institutions, hospitals, public transport and retirement homes. It complies with DIN 18040 for barrier-free constructions. In France, the integration of the module is an integral part of the building regulations. With this module, the door station is expanded to include a status display and a hearing loop.

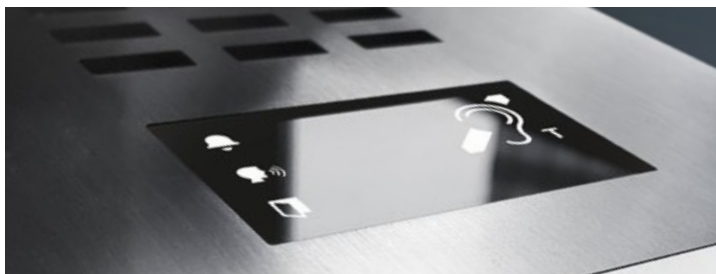







The status display with three pictograms (calling, speaking, door opening) assists communication for people with hearing impairment by visualizing the current status of the door station. The hearing loop or the induction loop is used for wireless sound transmission from the door station to the hearing aid. Using this function, you can meet the required norms, and also make communication, for example, with reception, significantly easier for everyone wearing a hearing aid. The hearing loop developed by DoorBird has an internal antenna, so that the design of the door station remains fully retained.

The door station can be supplemented with Braille on request so that visually impaired or blind people can feel the texts and use the door station intuitively.

MORE THAN 50 COLORS AND FINISHES!

Design your DoorBird individually and according to your wishes*

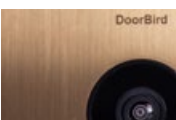
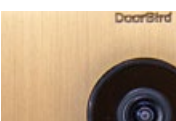
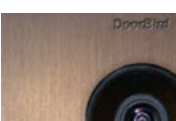
 Chrome-Finish, polished	RAL 1001	RAL 1003	RAL 1004
 Stainless steel, brushed	RAL 1016	RAL 1017	RAL 1037
 Bronze-Finish, brushed	RAL 2002	RAL 2004	RAL 3000
 Brass-Finish, polished	RAL 3007	RAL 3014	RAL 3020
 Titanium-Finish, brushed	RAL 4004	RAL 4005	RAL 4006
 Titanium-Finish, polished	RAL 4009	RAL 5002	RAL 5004
 Gold-Finish, brushed	RAL 5012	RAL 5013	RAL 5018
 Real burnished brass	RAL 5022	RAL 6000	RAL 6006
 Architectural bronze	RAL 6018	RAL 6019	RAL 6027
	RAL 7001	RAL 7004	RAL 7006
	RAL 7011	RAL 7015	RAL 7016
	RAL 7023	RAL 7033	RAL 7044
	RAL 8004	RAL 8011	RAL 8016
	RAL 8023	RAL 8028	RAL 9002
	RAL 9006	RAL 9007	RAL 9010
	RAL 9016	DB 703	Graphite Black (Raven Polar)

*The colors shown are available off-the-shelf for selected models only and are not binding. For the precise color determination, we recommend a valid RAL color register. For more options and custom solutions, contact us directly or use our Online Configurator.





CUSTOM SOLUTIONS

Unique properties and installation environments often require individual solutions. DoorBird can manufacture truly unique intercom systems according to your specific requirements. We combine high-quality mailbox and doorbell systems from well-known manufacturers with DoorBird IP video technology. Through the wall or fence-mounted mailbox systems, communication columns or bell panels - we customize each IP system to your needs and manufacture it individually.*



ACCESS CONTROL SIMPLIFIED

The DoorBird A1121 is a compact, IP-based multi-technology access control system that can also be installed as a stand-alone solution. It enables secure access control in areas where the installation of an IP video door station is not possible or desired, e.g. at back and side doors, garages and underground garages, storage and packing rooms or bicycle and machine rooms. It can also be used to control elevators.

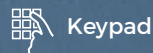
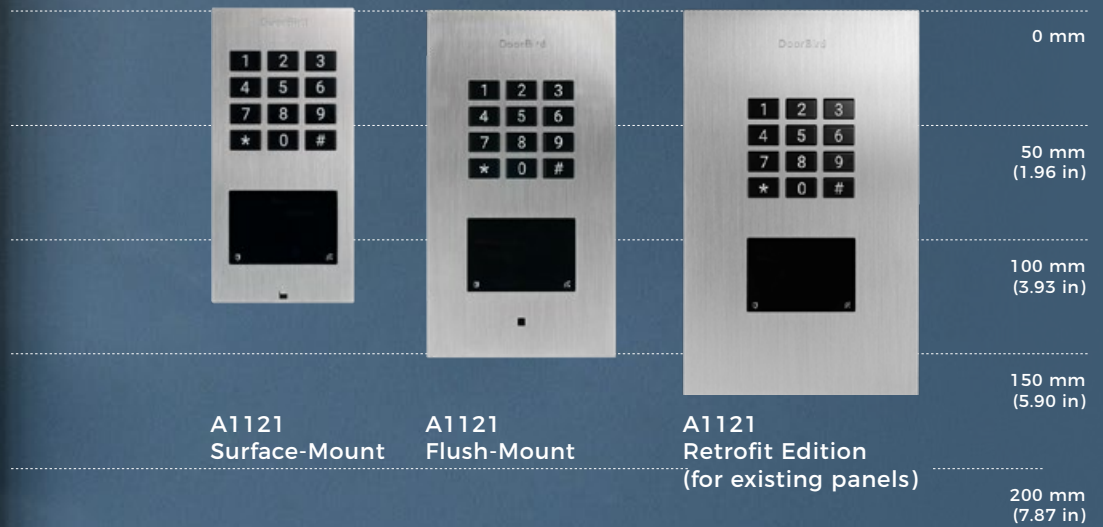

Keypad



125 KHz
RFID Reader



13.56 MHz
RFID Reader



Wiegand
Interface



WiFi enabled



Tamper
proof

A1101

IP VIDEO INDOOR STATION

The DoorBird IP Video Indoor Station is an ideal addition to any DoorBird system. When paired with our DoorBird IP Video Door Intercom, the Indoor Station delivers a live video stream, two-way audio communication as well as control of doors and gates. The Indoor Station is compact and designed to complement any environment.

The DoorBird Indoor Station has a touch display made of scratch-resistant tempered Gorilla® glass with intuitive user interface. It also includes configurable hard buttons with clear symbols for common functions.

This makes the operation

- intuitive and comfortable
- easy-to-use for every age group
- even with gloves on possible

Individual chime alerts can be selected for multiple DoorBird Door Intercoms to indicate from which entry the visitor is calling. When the DoorBird Door Intercom is rung, an LED light at the bottom of the Indoor Station flashes a visual alert. The color of the LED light can be customized for multiple DoorBird Door Intercoms.

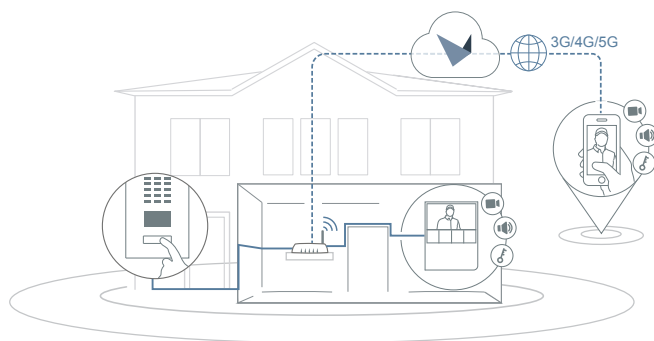

In less than 10 minutes the installation of the Indoor Station is completed. The DoorBird Indoor Station can connect to the network via WiFi or a network cable. If the Indoor Station is connected using a network cable, it can be powered via Power over Ethernet (PoE) for quick and easy installation. Should the Internet fail, all functions continue to operate within the local network. Once on the Internet, the Indoor Station can connect you to all your DoorBird Door Intercoms - anywhere in the world.

If more than one Indoor Station is used, room to room communication between all Indoor Stations is supported. A SIP phone can also be called at the touch of a button, e.g. to contact a concierge or property manager. Calls from a SIP phone to the Indoor Station and Door Station are also possible.



Benefits via IP

- Door opener and elevator control
- Visitor history (free Cloud Recording)
- Room to room communication, when using several Indoor Stations
- SIP support, e.g. for concierge or facility manager calls
- Weather forecast display
- Home and building automation control (IP, TCP, HTTPS, relays etc.)
- Configurable via the DoorBird App worldwide

Intuitive User Interface

- 4" True Color Touch Display
- Scratch-resistant tempered Gorilla® glass

Two-way Audio Communication

- HD Audio, up to 102 dB
- More than 50 doorbell sounds available

Compact Housing

- 5 hardware buttons for main functions
- Configurable RGB LED status bar

Unlimited Range

- Supports WiFi, Ethernet, PoE
- Support for multiple DoorBird IP Video Door Stations

Further Options

- Automatic door opening system, e.g. for offices

Table Stand "A8003" optional



Configurable tile view

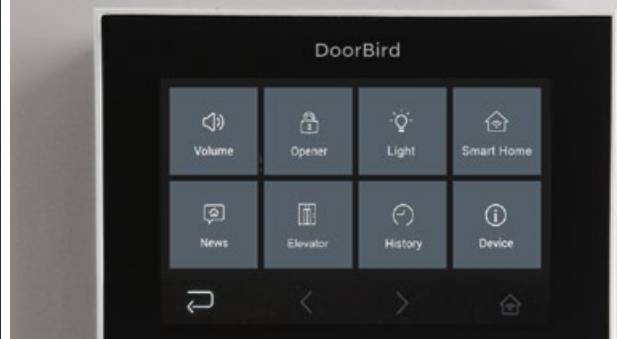

Room to room communication



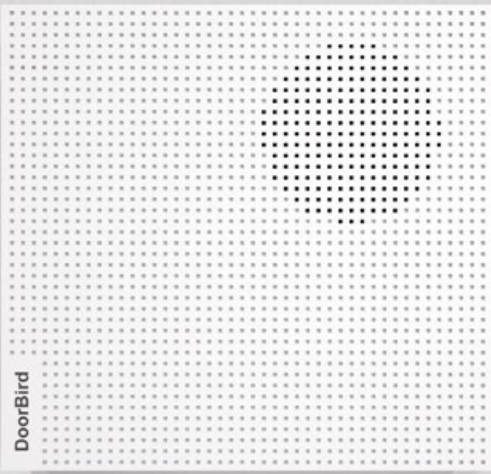

A1061W

IP DOOR CHIME A1061W

- Front door and storey-call option
- WiFi, Ethernet, PoE
- Configurable via App worldwide
- Works online or on local network
- Multiple ringtones available (50+)
- Unlimited range, works anywhere
- Easy to hear, discreet design



IP VIDEO DOOR STATION D1101UV UPGRADE FOR D201/D202

Upgrades

- Larger camera angle: 180° hemispherical lens
- Higher image resolution: HDTV 1080p
- Latest sensor technology: 4D motion sensor with distance configuration
- More powerful speaker
- Classy and discreet design



2-WIRE ETHERNET POE CONVERTER A1071

Transfer network data (Ethernet) and power (PoE) with a simple two-wire cable over long distances.

- Use of existing cabling
- Only a two-wire cable required for both data transmission and power supply (PoE)
- Compact design, robust housing
- Easy and fast installation
- Suitable for mounting on walls, ceilings and in control cabinets

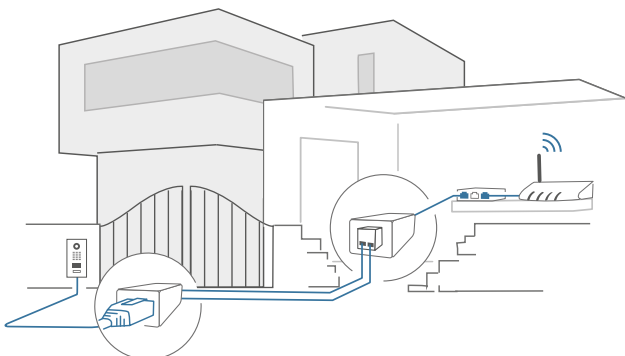

INTERNET FIREWALL A1051

- Effective protection against network attackers from the outside and the inside
- Easy installation and configuration
- Integrated status display
- Compatible with smart home systems
- Flexibly adaptable to individual network requirements (IP whitelist)



A1081

IP I/O DOOR CONTROLLER A1081

- Tamper-proof control of up to three doors or gates
- Encryption according to banking standards
- Monitoring of two external sensors
- Three freely configurable bi-stable switching relays (for continued or scheduled toggle between open and closed)
- The latching relays keep their state even in the case of power outage
- Wireless network, Ethernet, PoE
- Alarm notification via push notification on smartphone and tablet
- Suitable for mounting on walls, ceilings and in control cabinets

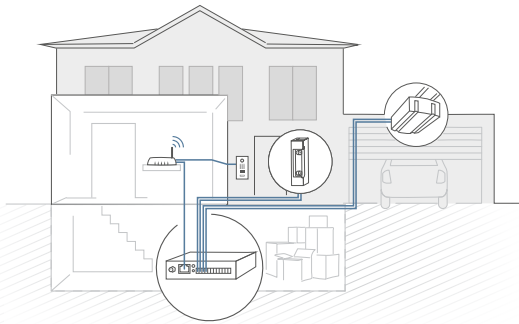

A8003

TABLE STAND A8003

For DoorBird IP Video Indoor Station A1101 with anti-slip pad for optimal surface adhesion



A8001

WEDGE CORNER WALL-MOUNT ADAPTER A8001

For D1101V Surface-mount and D1102V Surface-mount, 7,5°, mounted vertically down or up



A8002

ANGLE CORNER WALL-MOUNT ADAPTER A8002

For D1101V Surface-mount and D1102V Surface-mount, 45°, mounted left or right



A8007

BLUETOOTH KEYFOB REMOTE A8007

2.4 GHz Bluetooth Keyfob for D11x, A1121 and D1812 series, with integrated 13,56 MHz NFC-A tag

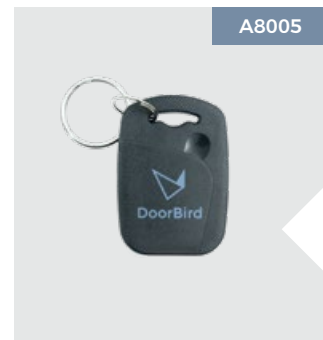

A8005

DUAL-FREQUENCY RFID TRANSPONDER KEY FOB A8005

125 KHz (EM4100) and 13.56 MHz (MIFARE® DESFire® EV2 8K), for A1121, D21x and later

REFERENCES AND INTEGRATIONS

DoorBird fits perfectly into any environment. With our "Made in Germany" products we inspire customers all over the globe. More than 100.000 IP Video Door Stations have already been installed worldwide.

Via our open interface "DoorBird Connect", DoorBird can be integrated into third-party home and building automation systems. Connect your DoorBird to your favorite components, such as traditional door openers, classical door chimes, smart locks, home servers, Hubs, NAS and NVR. This ensures the full control over your Smart Home and the Internet of Things (IoT), and you will benefit from the additional comfort and increased security.

Compatible with:



D2T01V Stainless steel
Slovenia
Photo: Go4Panda d.o.o.



D2101V Titanium-Finish
Netherlands
Photo: Consepto Hekwerk



D2101KH Stainless steel
USA (California)
Photo: SB Smarthomes, Inc.



D2101KV Stainless steel
Netherlands
Photo: Consepto Hekwerk



D1101KH Stainless steel
USA (California)
Photo: ReelTime Sight & Sound



individual solution
Israel
Photo: Golan Systems AV Ltd.

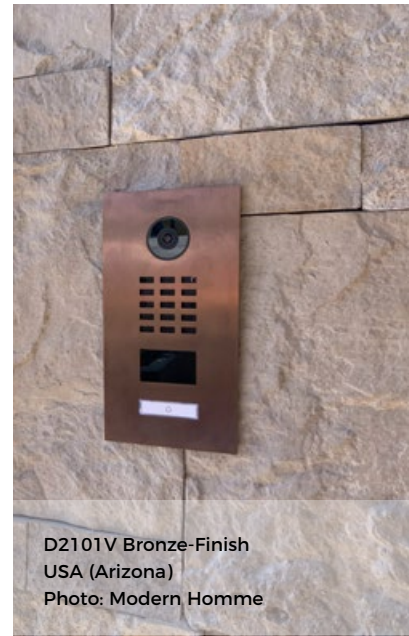

D2101V Bronze-Finish
USA (Arizona)
Photo: Modern Homme



D2102V RAL 7016
Germany
Photo: Kontec GmbH



D2101V Stainless steel
Bulgaria
Photo: Drax Ltd.

SUSTAINABILITY AT BIRD HOME AUTOMATION

DoorBird products are developed and manufactured in Germany by Bird Home Automation GmbH. All of our products Made in Germany are built with the utmost care and precision at our Berlin factory and delivered to our customers all over the world.

As part of the ASSA ABLOY Group, we belong to the Science Based Targets Initiative (www.sciencebasedtargets.org), which enables us to continue our significant reductions in greenhouse gas emissions throughout the value chain.

We are convinced that our company will benefit from evidence-based targets on multiple levels. By adopting a net zero target in line with a 1.5°C future, we are making a vital contribution to limiting the devastating impacts of climate change.

We will halve Scope 1 and Scope 2 emissions at our own company by 2030.

To do so, our over 130 employees work daily to develop, produce and sell our products in ways that protect the environment. Our focus is on unbeatable product quality and durability coupled with first-class service to guarantee customer satisfaction. For us, Made in Germany is a philosophy we embrace and not just a label.

Sustainability is of crucial importance to our modern society. We take responsibility for a sustainable future and reconcile the demands of ecology, economy and social equity. With our outstanding products, we are a strong partner to our customers in the area of sustainable building modernisation. This is reflected in many areas of our company:

RESEARCH AND DEVELOPMENT

We develop our innovative products as sustainably as possible. Our staff in the Research and Development Department take care to create products that preserve resources and ensure reliability and durability. The products enjoy a long service life thanks to their excellent quality, which reduces material input and avoids returns.



PRODUCTION

In production, we prioritise the purchase and use of green materials and eliminate hazardous substances. A particular concern is to use as little packaging as possible and to make sure that what we consume is biodegradable. We have partnered with many of our suppliers to develop a reusable packaging system according to the principle of returnable materials. By doing so, we ensure resource efficiency in transport and storage. Our consistent focus is on the entire production process. For example, we calculate our monthly electricity consumption, material waste and many other factors to detect and eliminate unplanned surplus consumption.

And we take more than just random samples: Every single

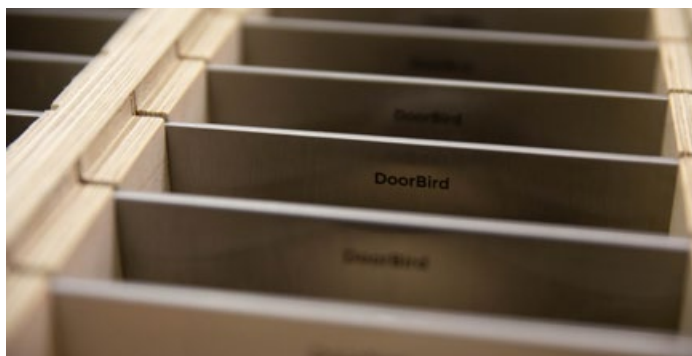

product that leaves our factory is rigorously tested for quality and visible flaws. This reduces unnecessary returns and resource consumption. We work tirelessly to make our supply chain as transparent, ecological and socially equitable as possible.

SERVERS

Our performance as an industrial company has been nothing short of stellar: without exception, all of our servers in Europe run on 100% green electricity. This reflects our commitment to ecological responsibility in line with the government's expansion of renewable energies, but without neglecting commercial challenges.

STAFF

Our employees are committed to upholding our Environmental, Social and Governance (ESG) policy from the moment they join our organisation. In addition, we provide regular information on various environmental protection issues and highlight actionable options for putting them into practice in our employees' everyday work and personal lives.

For more information about sustainability, visit www.doorbird.com and www.assaabloy.com

DoorBird is a product of the
Bird Home Automation Group.

Headquarter in Berlin, Germany
Bird Home Automation Group

US Offices in San Francisco, CA
and Jacksonville, FL

DoorBird
+1 (800) 805 3856
hello@doorbird.com

